

10 HEDGES & PAVINGS

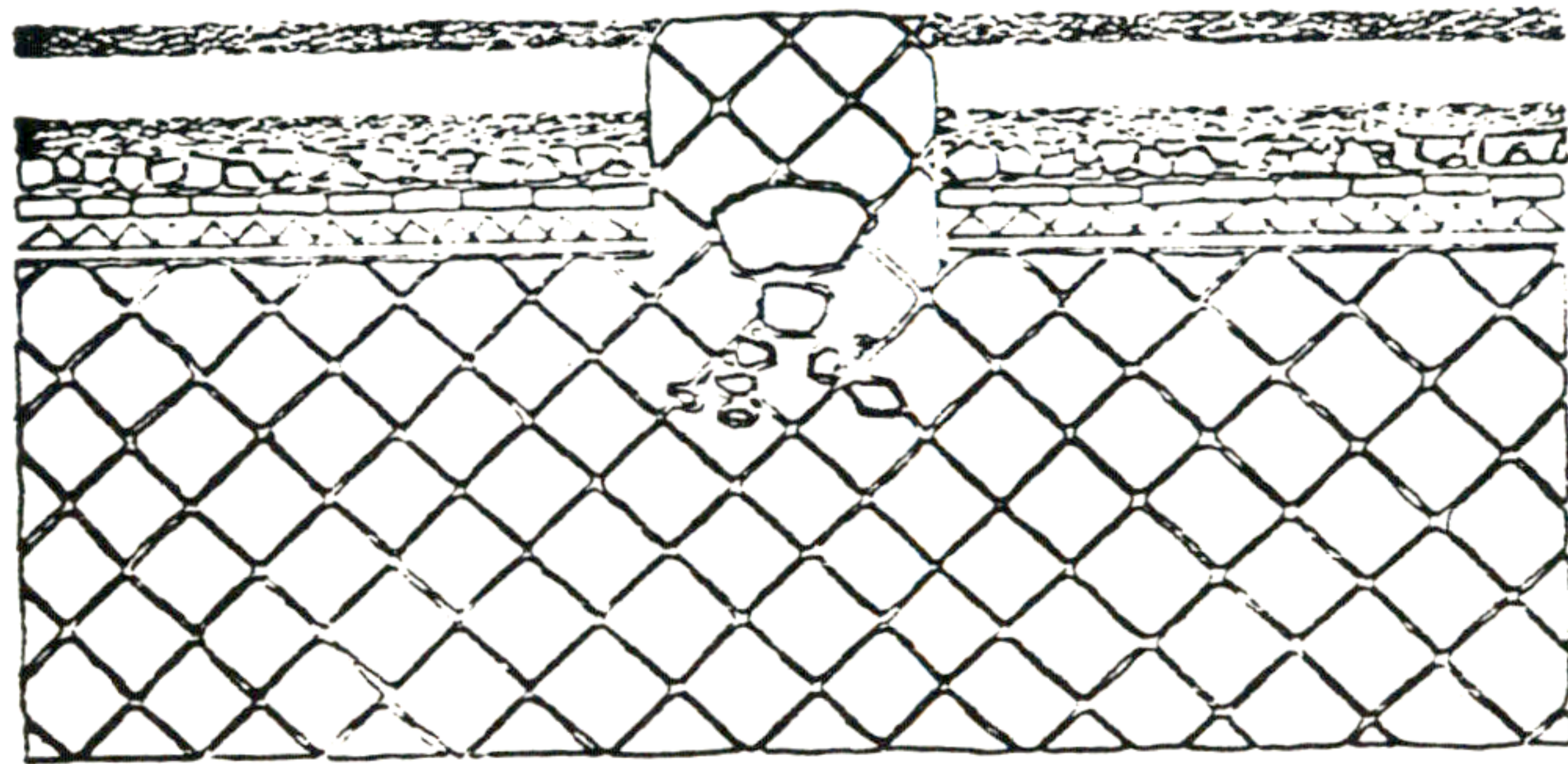

TRANSITIONS

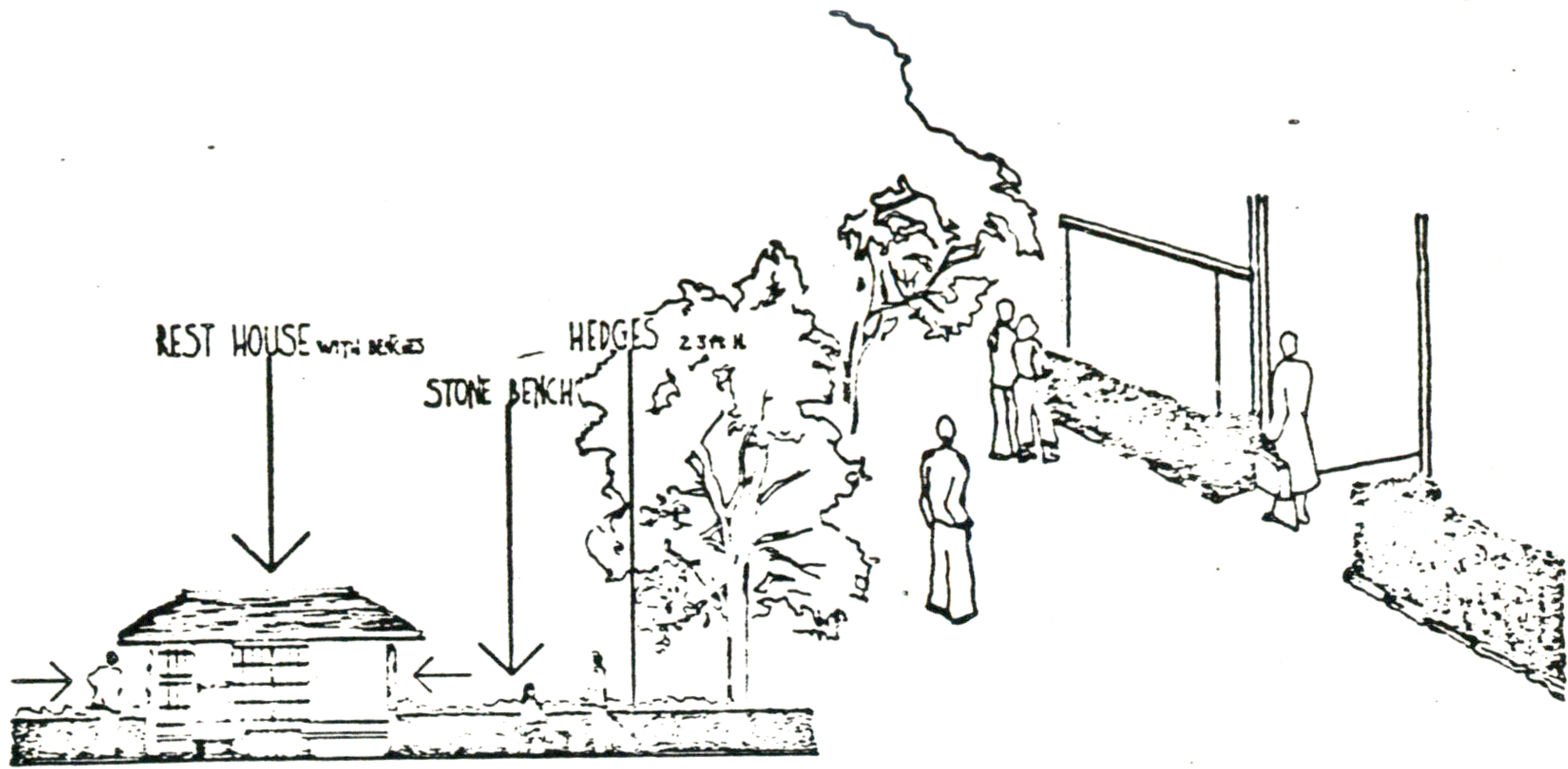

1

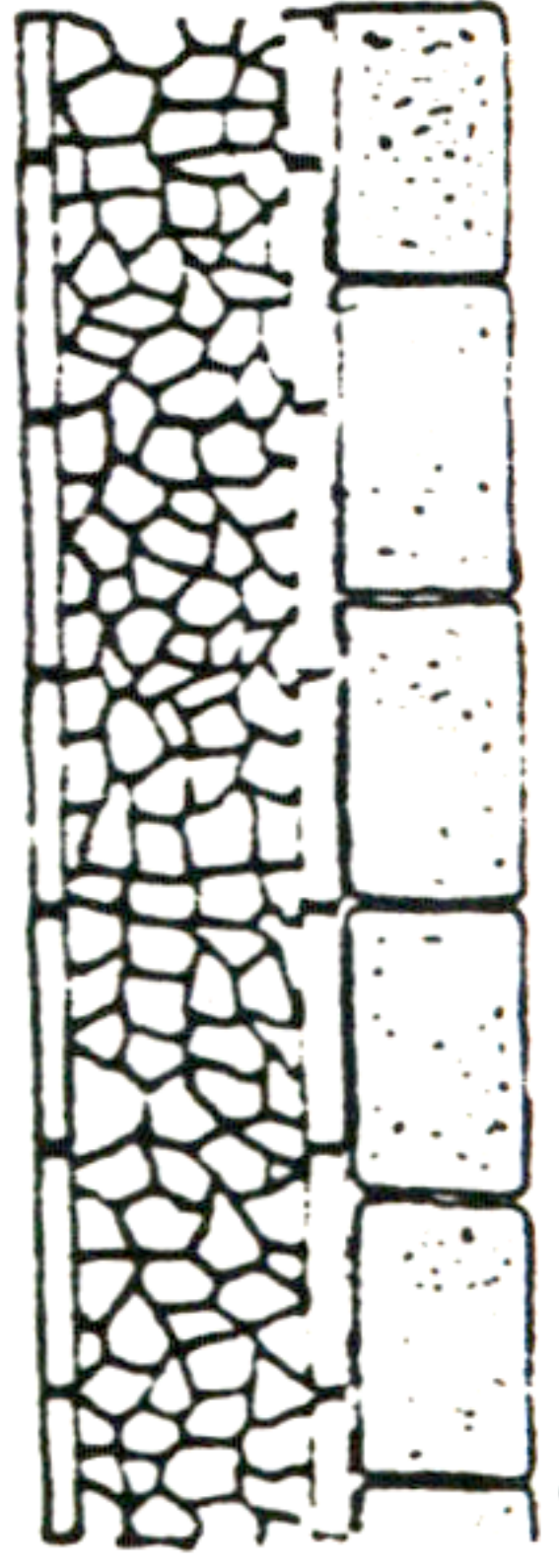

2



3

10 HEDGES & PAVINGS

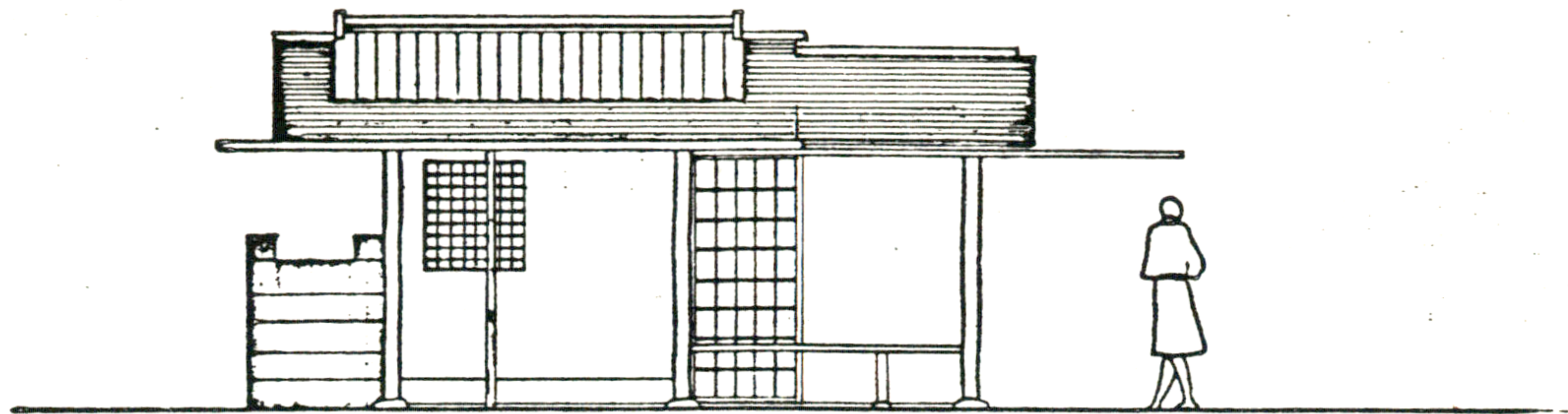

REST HOUSE

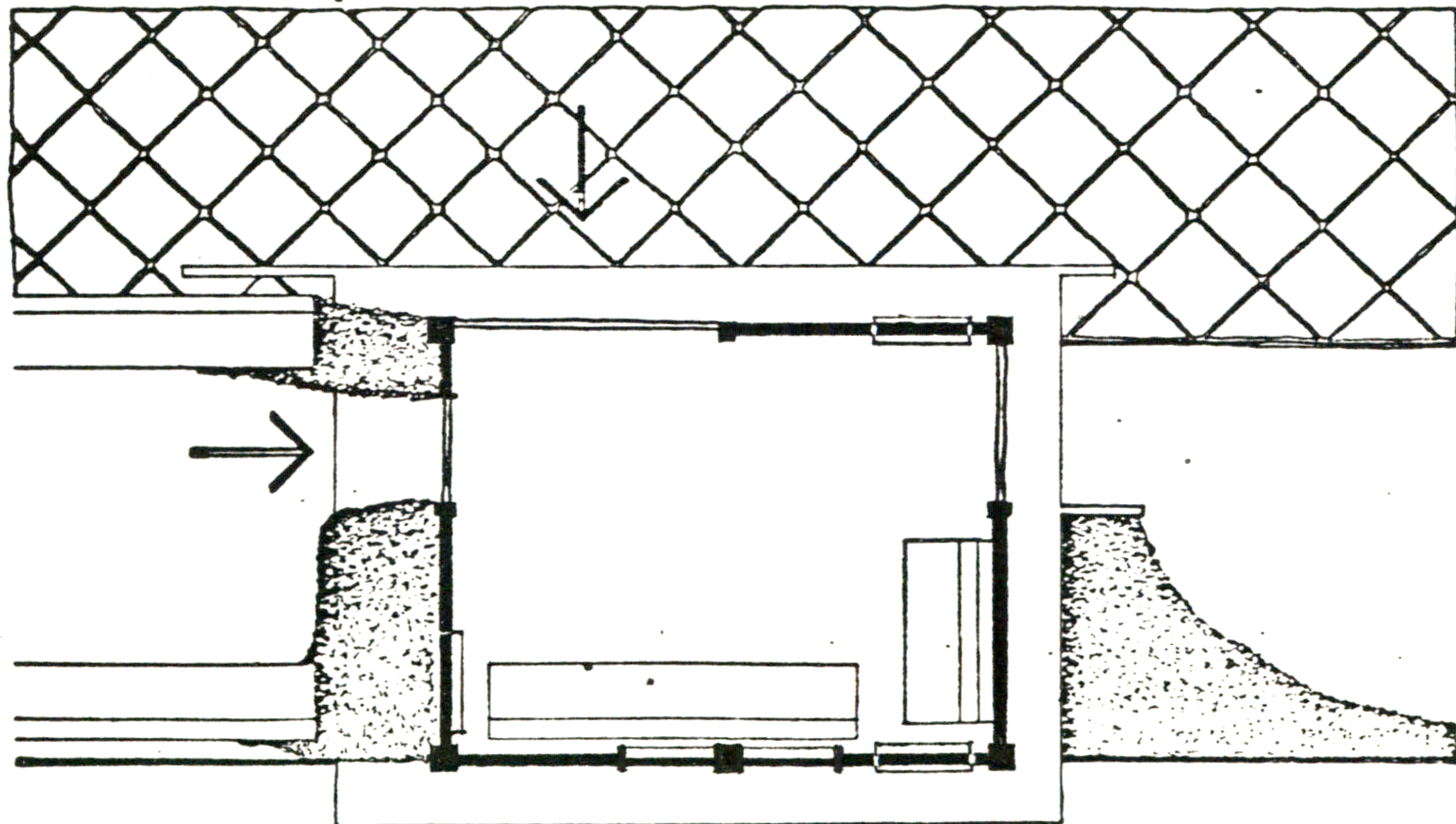
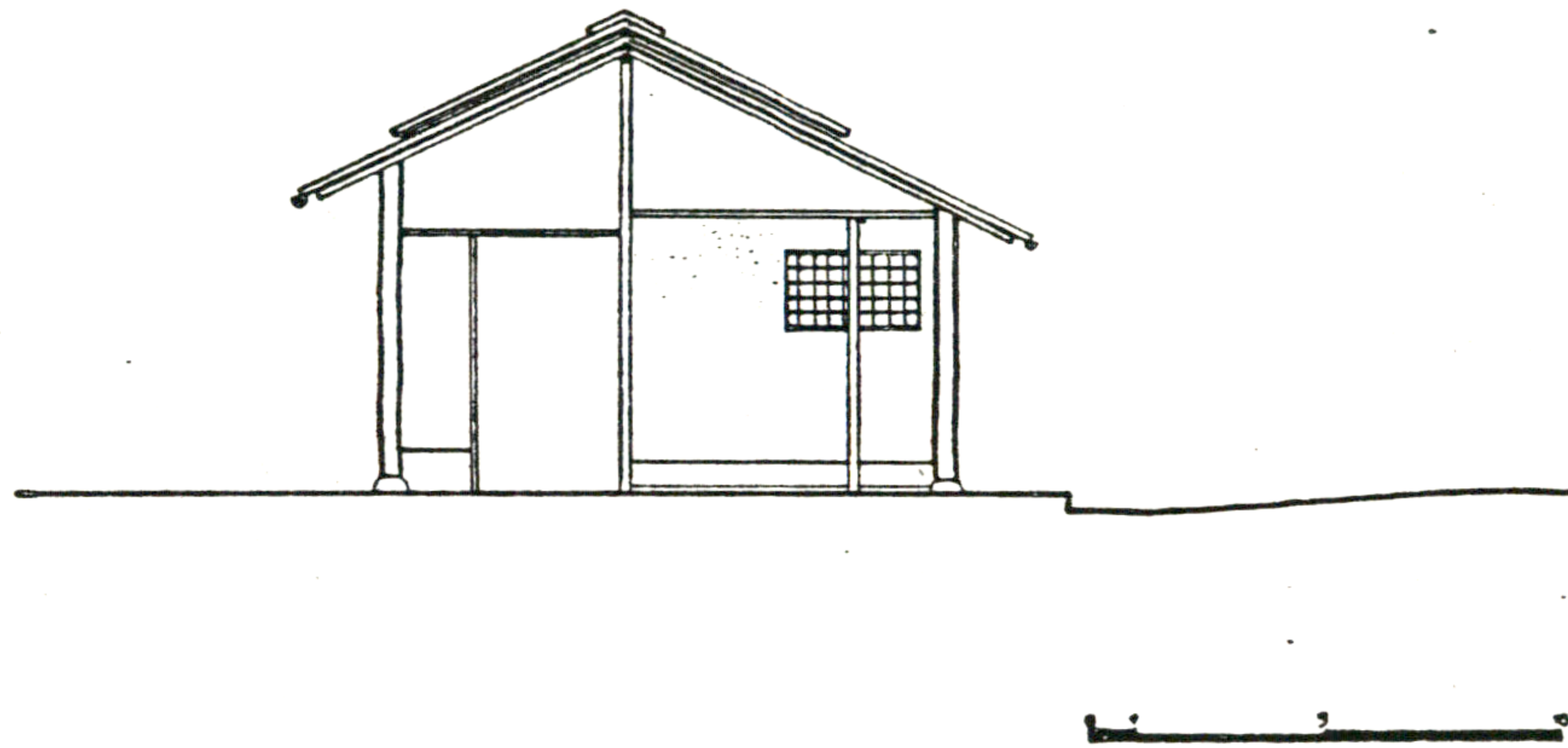

Takeshi Kimura

32 APT. HOUSE

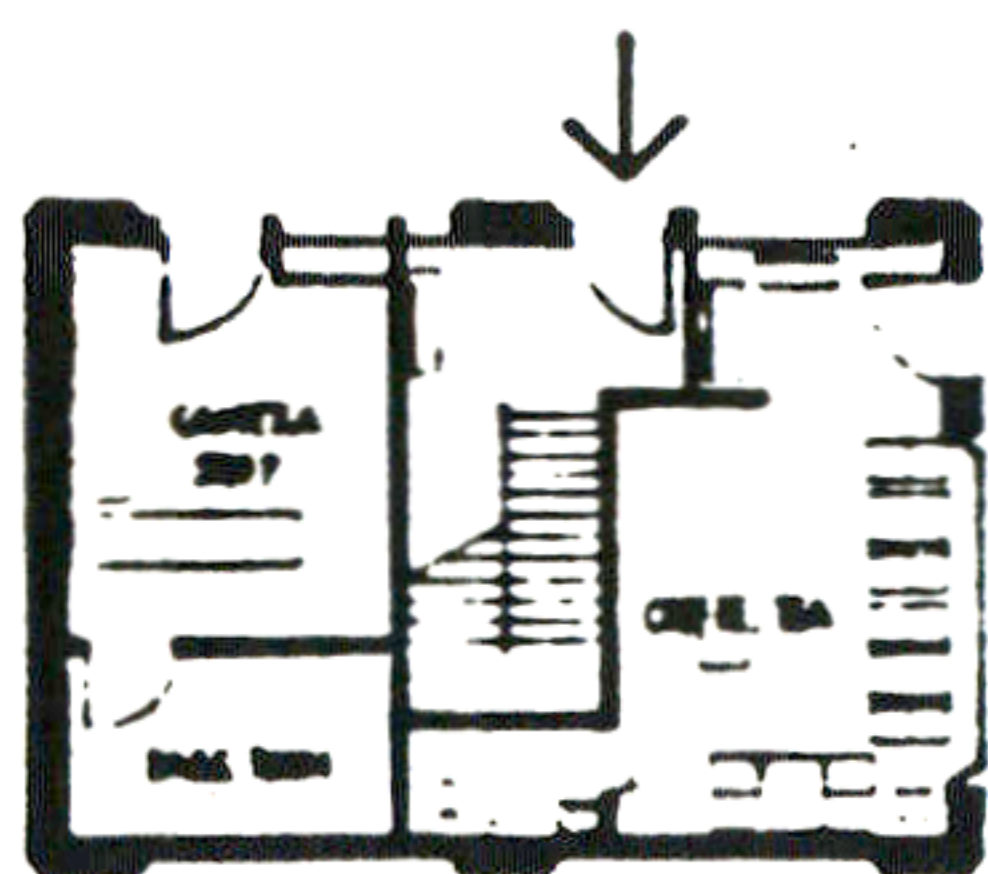

GROUND FLOOR

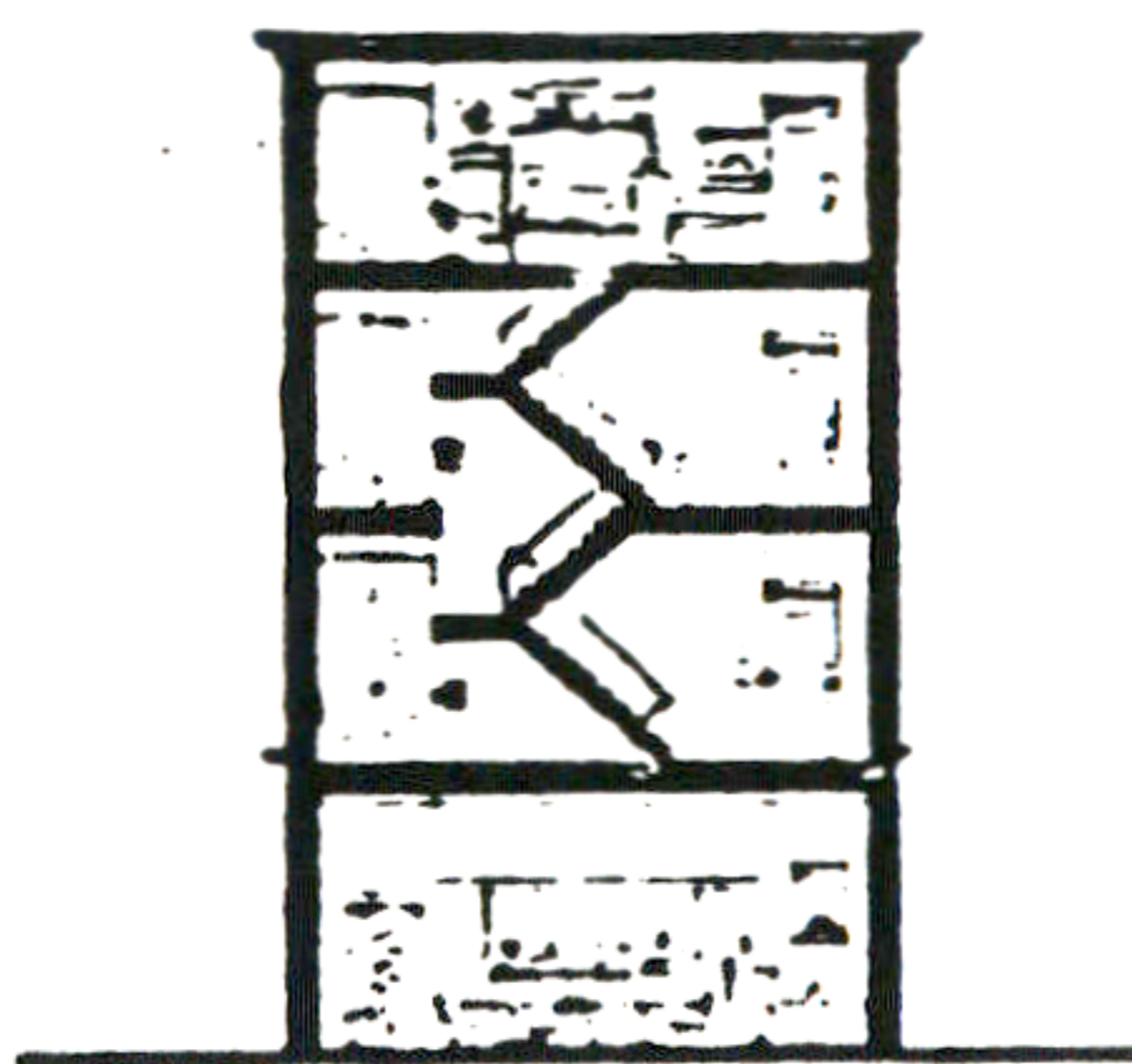

SECTION



TYPICAL FLOOR 2, 3, 4 FL.

TAKESHI KIMURA

61. CAR DEALER SHIP

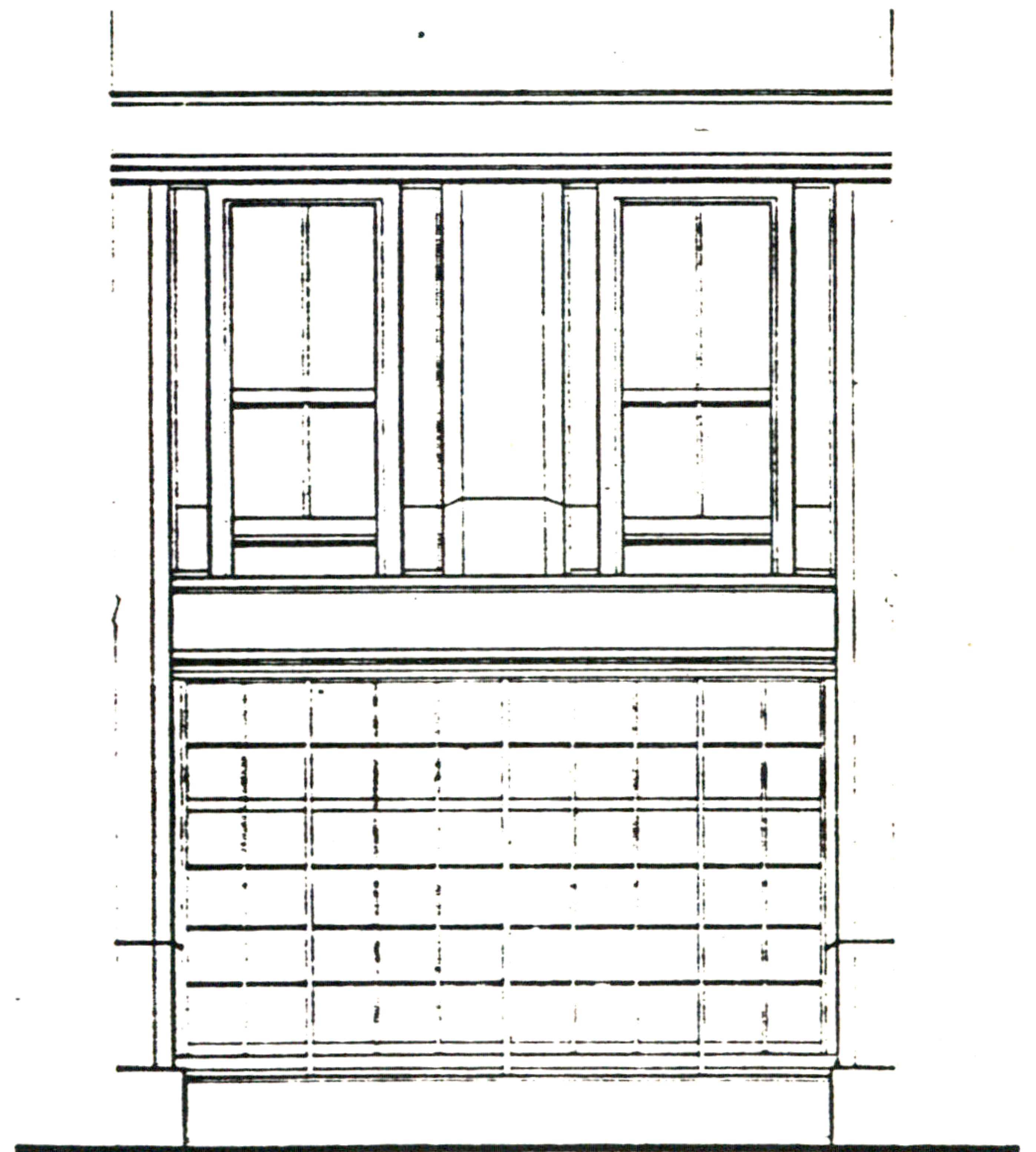
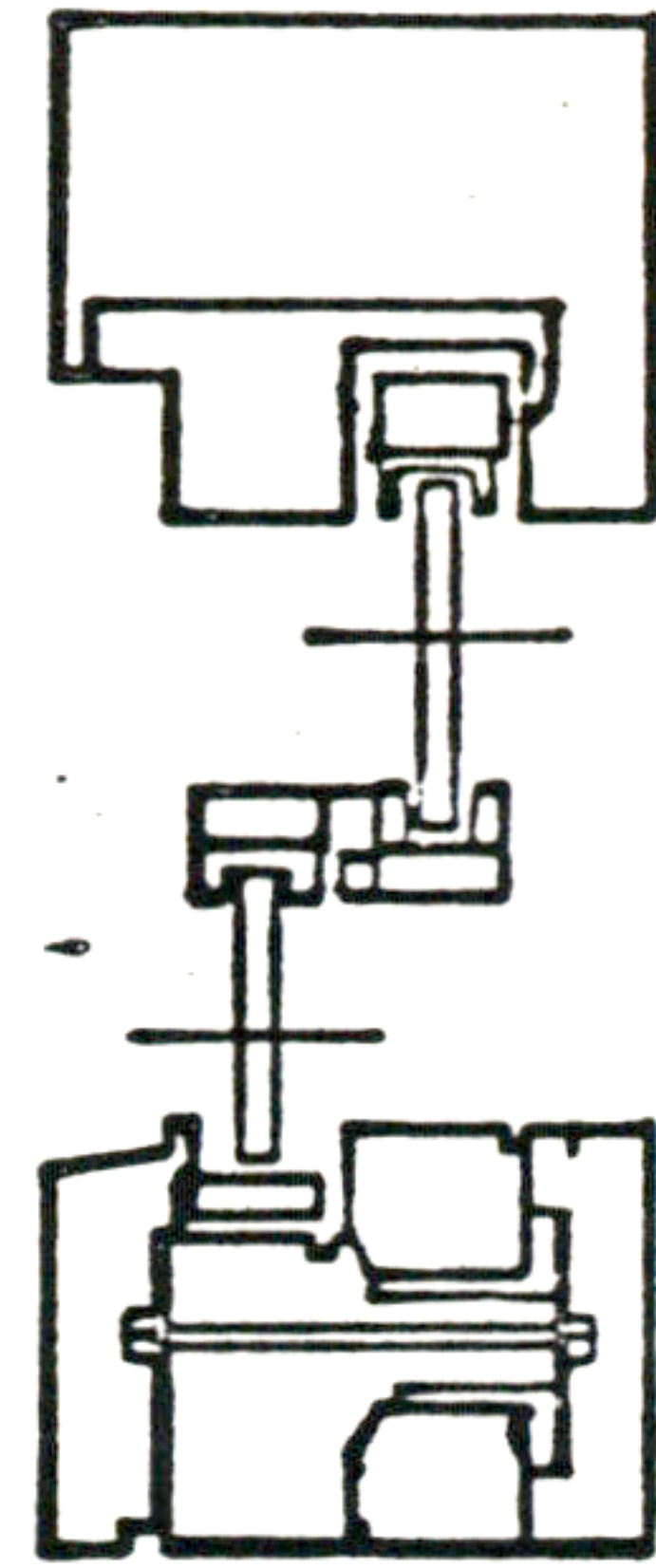
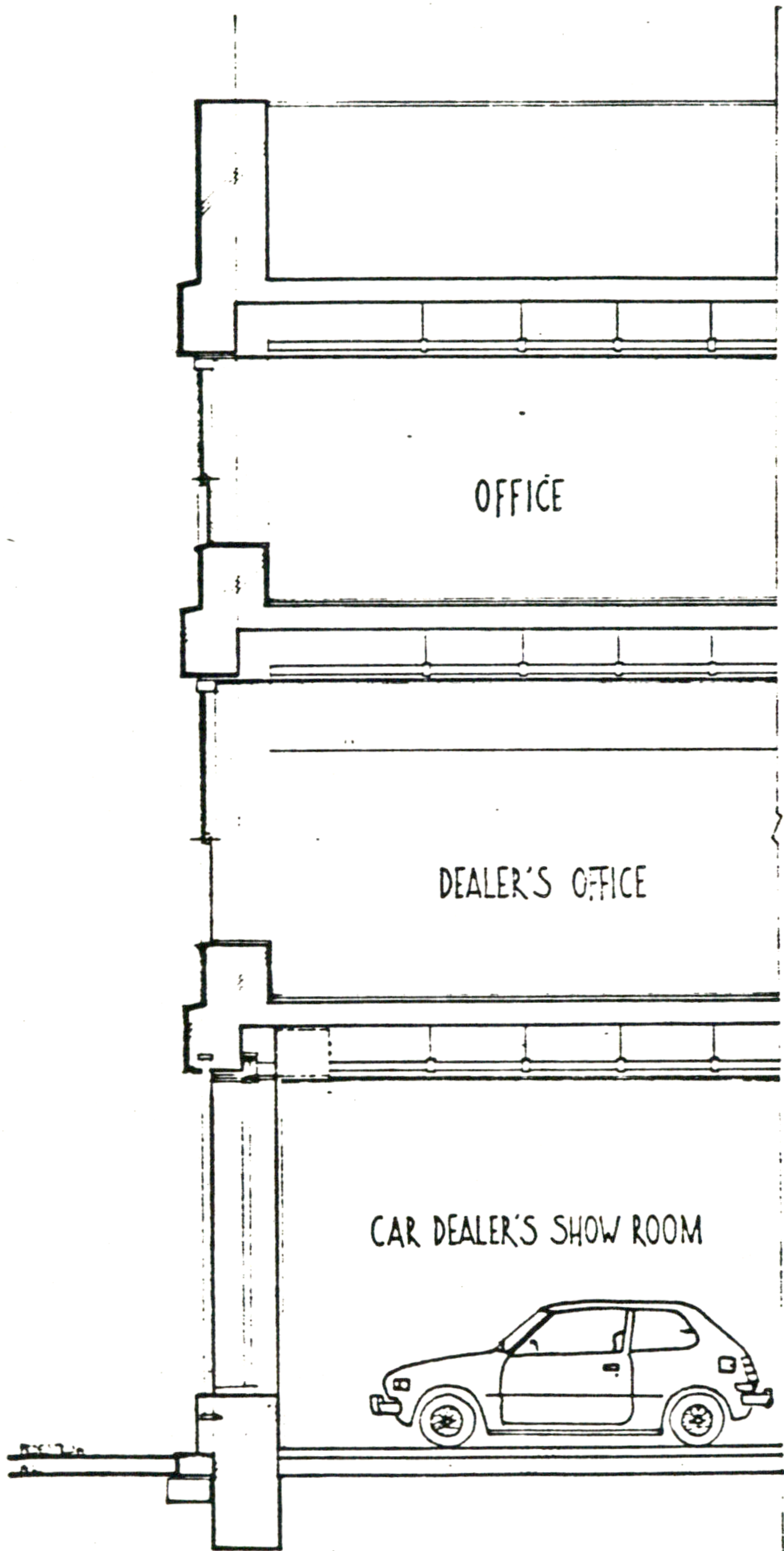

WINDOW DETAIL

61. CAR DEALER SHIP

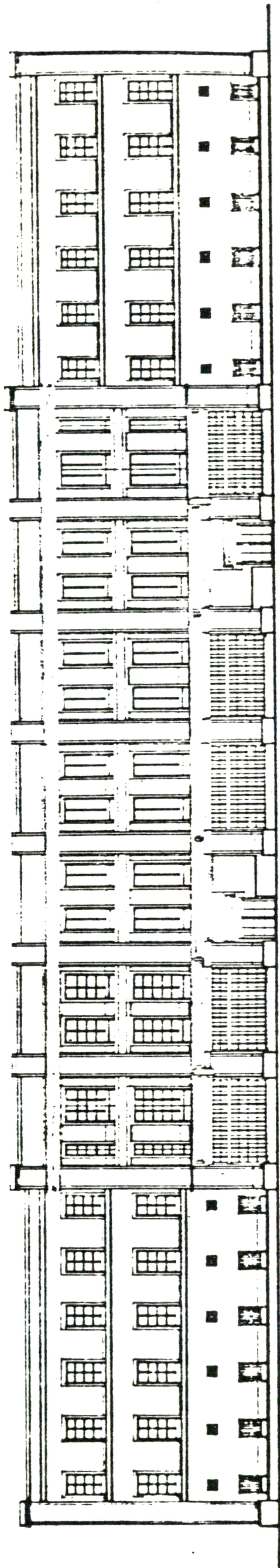

FRONT ELEVATION

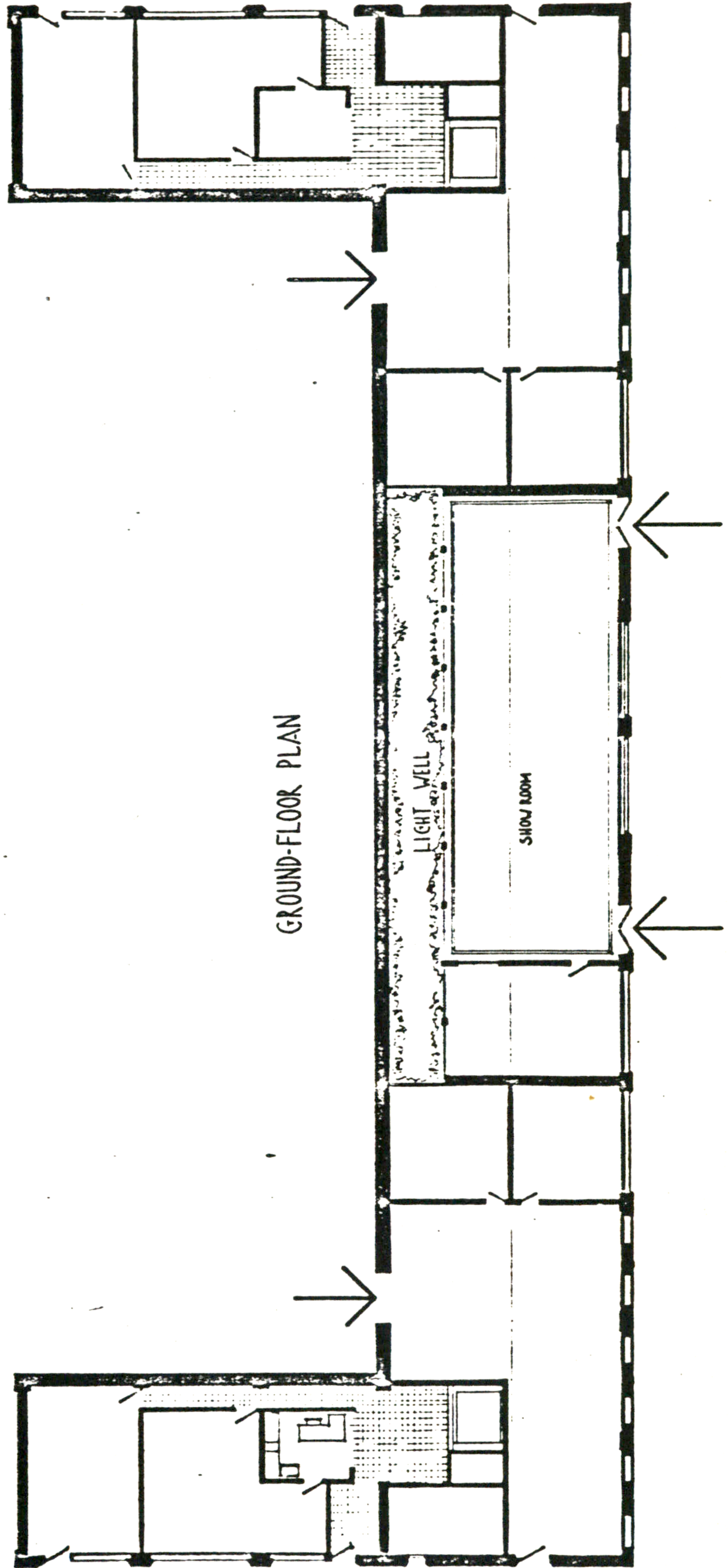

GROUND-FLOOR PLAN

Takeshi Kimura

61. CAR DEALER SHIP

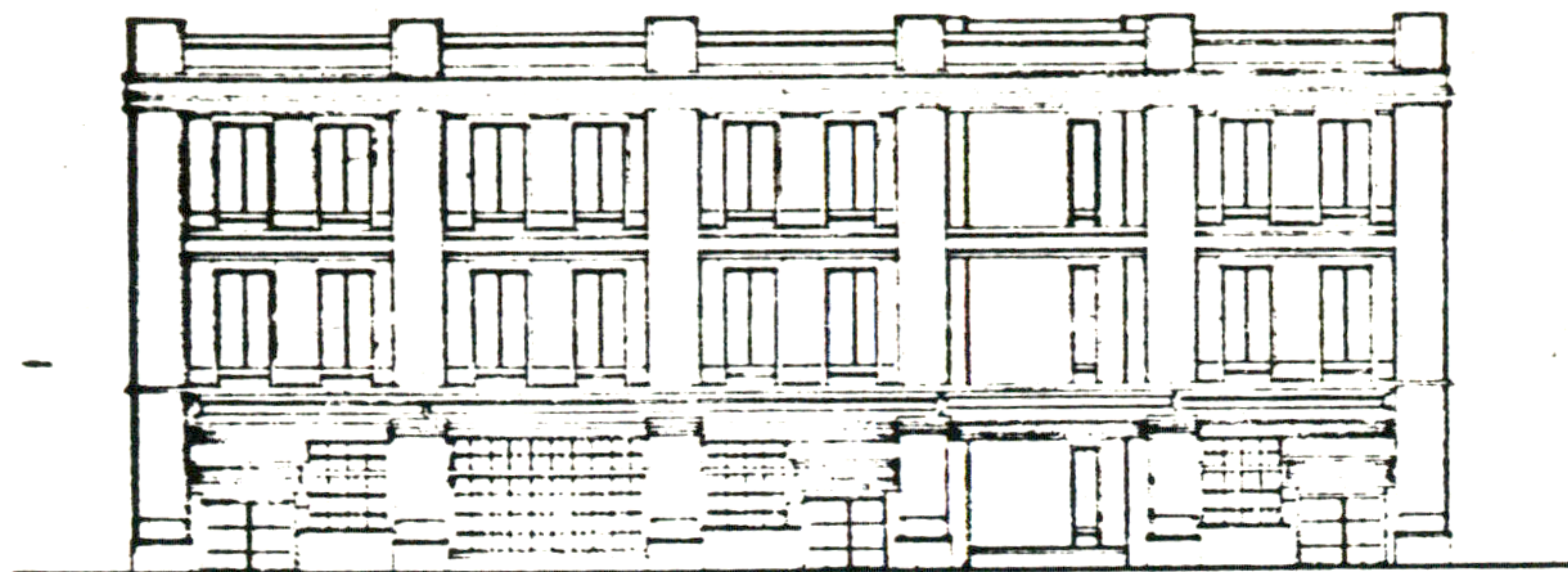

WEST ELEVATION



SECTION

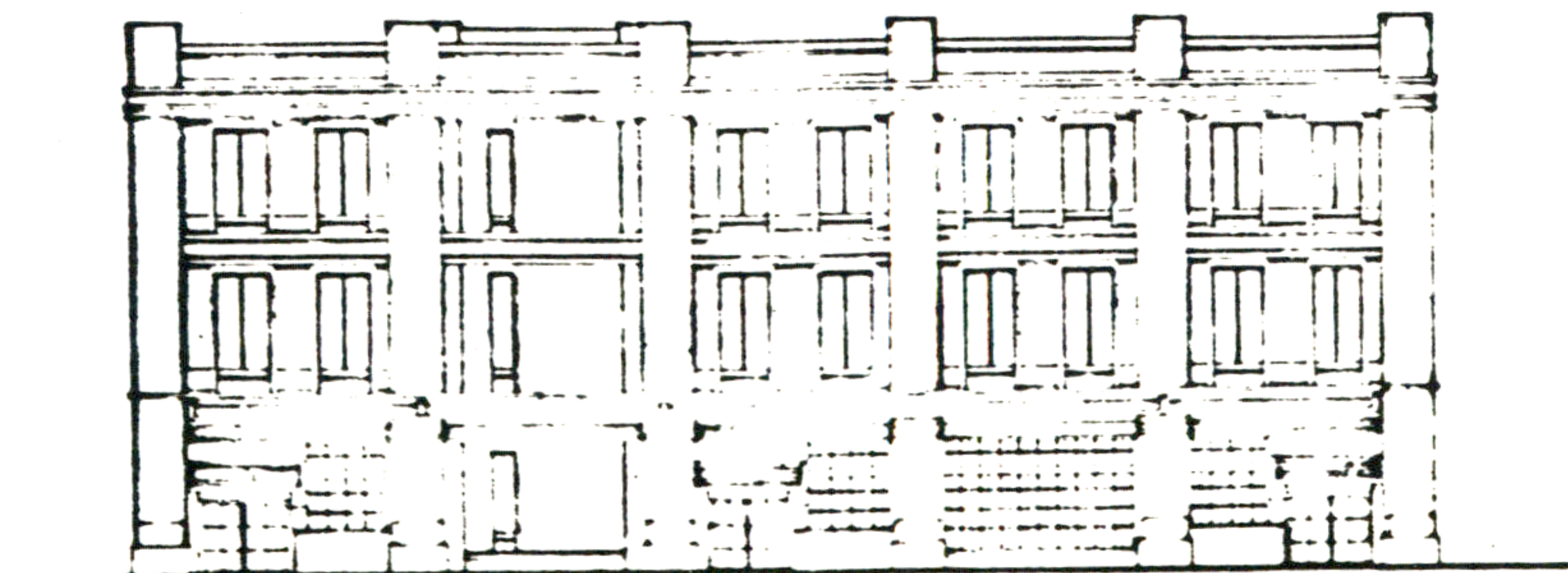

EAST ELEVATION

Takeshi Kimura

STREET LAMP

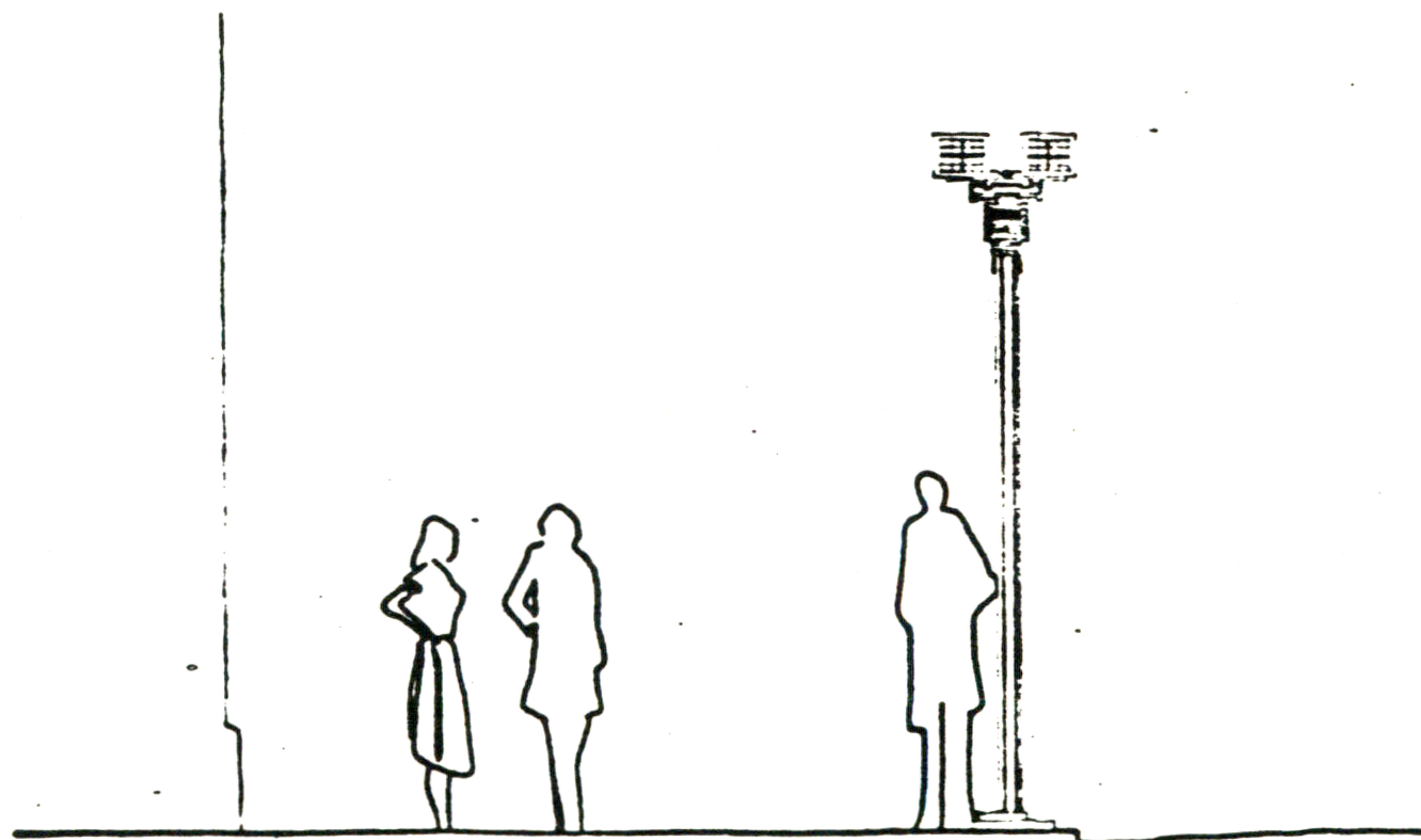
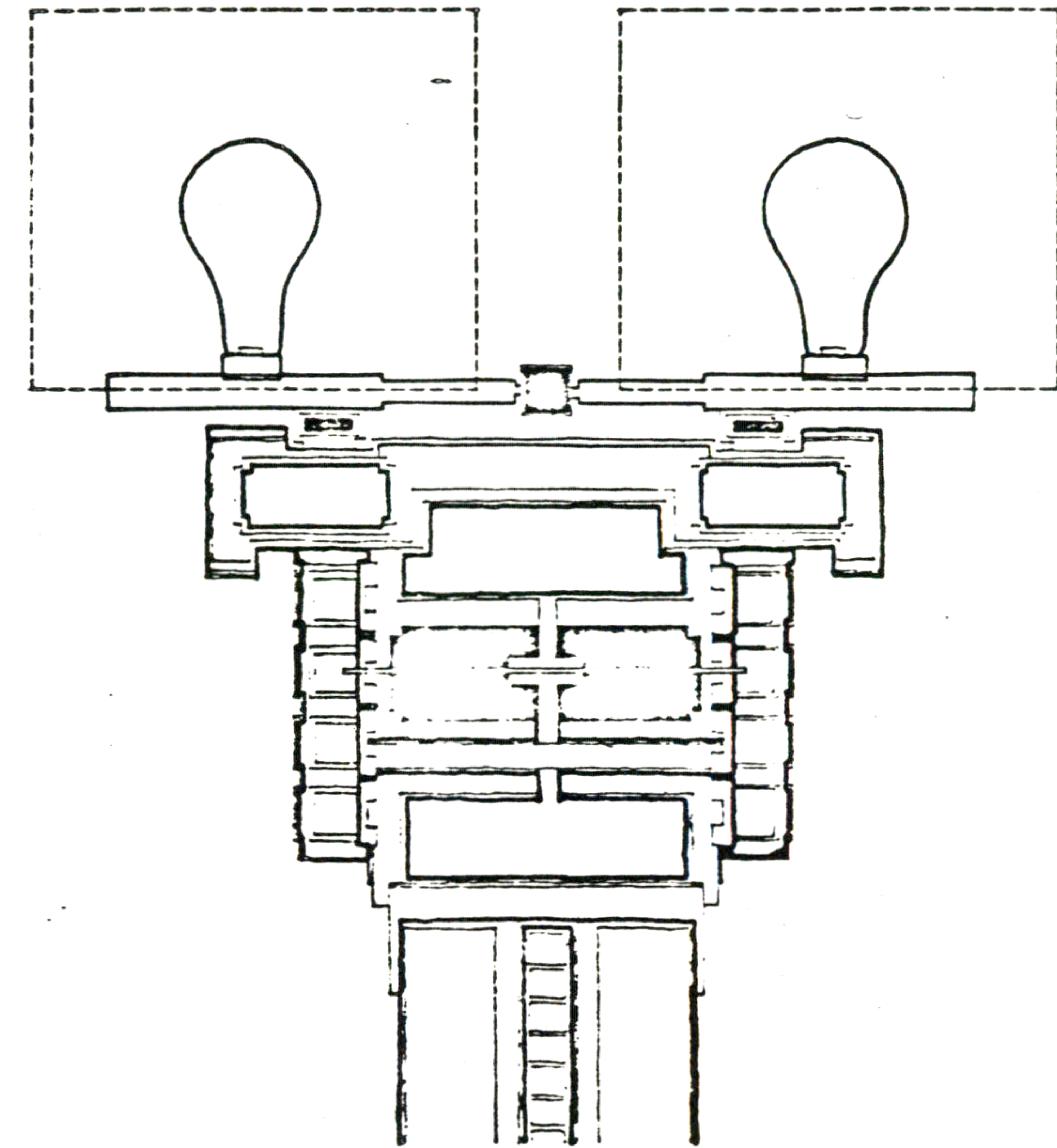

Takeshi Kimura